

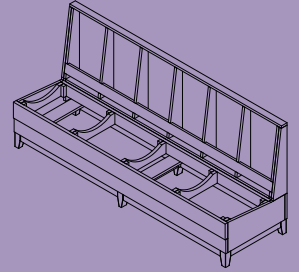

SOFT TOUCH
FURNITURE

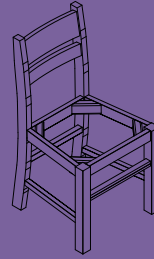
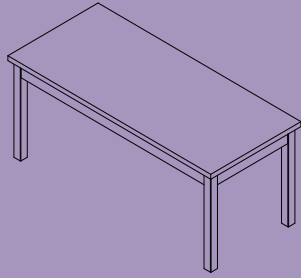
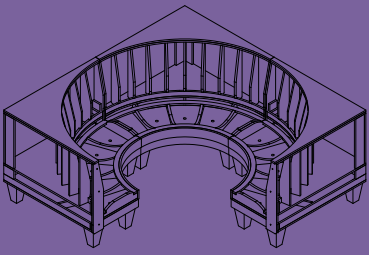

Designers Guide

Design Approach

Standards

Shapes and Sizes

Layouts



ABOUT US



Soft Touch Furniture, a U.S. manufacturer based in Ohio, has been producing high-quality custom commercial furniture for the past 40 years. Our state-of-the-art production facility, combined with design excellence and skilled craftsmanship, allow our customers to enjoy world class quality and direct from the manufacturer pricing.

WHAT MAKES US DIFFERENT

WE ARE THE MANUFACTURER

Soft Touch Furniture is an industry leader in durable, high quality commercial furniture and has an excellent reputation for affordable, custom-made products, and excellent customer service.

We know that your project demands special attention. When you partner with Soft Touch Furniture, you receive expert knowledge, personal attention, and competitive pricing—a combination that sets us apart in the commercial furniture manufacturing industry. We are proud of our superior attention to detail and outstanding craftsmanship.



MADE IN THE USA

Our team of professionals, from designers to builders to installers, ensures each piece is produced to your exact specifications. From a single piece to a complete furniture package, we are your one-stop source for premium custom furniture at very competitive prices.

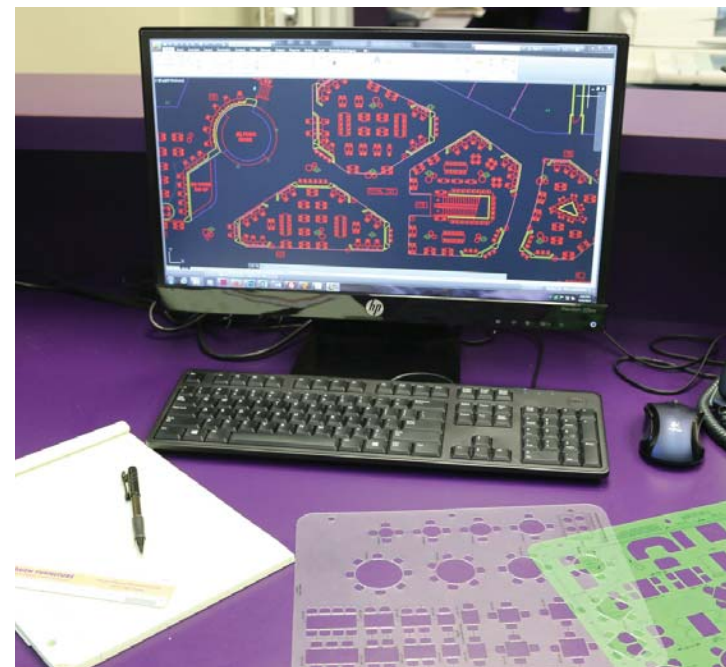

LET SOFT TOUCH FURNITURE HELP YOU CREATE YOUR VISION FOR YOUR SPACE

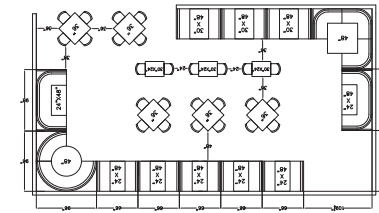

At Soft Touch Furniture, we pride ourselves in not only making beautiful high-quality furniture, but also doing everything we can to get you exactly what you want in terms of feel and fit. This design guide has been created to help you achieve the perfect balance for your establishment.

Need Design Help?

Soft Touch Furniture provides this guide to help you plan your own space. But we also offer expert design assistance and services if you wish it.

Space planning and seating capacities... pages 3 – 4

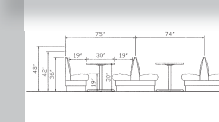

- Design approach
- Space allocations
- Seating standards

Standards... pages 5 – 8



- Bar standards
- ADA standards
- Booth and table seating standards

Size and Layout... pages 9 – 12

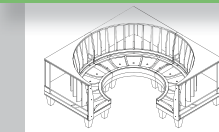

- Booth shapes
- Height differences
- Example layouts

Specifications... pages 13 – 18



- Fabric and foam
- Fire codes
- Design assistance



Design Approach

Successful furniture design blends the physical space with the vision for the environment. In most hospitality and commercial establishments, one of the primary business goals the furniture must support is to maximize occupancy and efficiency, both of which will help drive revenues. Whether your project is a restaurant, a hotel lobby, or a higher education cafeteria, site measurements are a must in order to determine the size and quantity of the best commercial furniture solution. The following information outlines various standards and approaches to mapping out the most popular hospitality space—dining areas.

A dining area should have a natural flow, from the lobby to the bar to the dining room to the kitchen. For optimal results that allow your customers to enjoy your environment and your staff to operate efficiently, use the below guidelines to establish the ideal floor plan for your dining experience. In many cases a healthy combination of booths, various size tables, and private spaces give the best chance to maximize revenue.

Seating Capacity

The architectural standard for dining suggests that 300 square inches be allowed per diner. However, some establishments may call for more or less allocation. For instance, fast food restaurants, quick serve coffee shops, diners, lunchrooms, or similar spaces can get by with less space per diner. On the other hand restaurants such as fine dining restaurants, pizza shops, Mexican restaurants, and many Asian style restaurants may require more table space for larger food items, special utensils, various condiments and sauces, and similar.

Tables come in different shapes and sizes, both of which have a big impact on seating capacity. Some examples of table shapes are:

- Square
- Round
- Rectangle
- Oval
- Half circle
- Drop Leaf
- Corner
- Boat
- Arc Rectangle
- Racetrack
- Custom

PLANNING STEPS

- **Step 1: Grab a Tape Measure**
Measure the interior space of your area. Note location and dimensions of features such as doorways, windows, emergency exits, counters, server stations, bar, and any other feature that takes up floor space or that must be accounted for in the floor plan.
- **Step 2: Pencil and Graph Paper**
Sketch a detailed, scaled outline of your floor plan and its features using the measurements.
- **Step 3: Select Dining Seating**
Select seating and table sizes that meet your needs and add those to the sketched floor plan.

DINING AREA SPACE ALLOCATIONS

- Spacious Dining: 14 sq ft/person
- Cafeteria and Restaurant Dining: 12 sq ft/person
- Banquette, Institutional and Fast Food Dining: 10 sq ft/person

AISLE ALLOWANCES

- Chair back to chair back: 18" – 24" aisle 6" minimum for access
- Table corner to table corner: 24" – 36" aisle 12" minimum for access
- Table side-by-side: 16" – 18" aisle 3" – 6" for no access
- Service aisle: 28" – 36" aisle

ACCEPTABLE TABLE SPACING

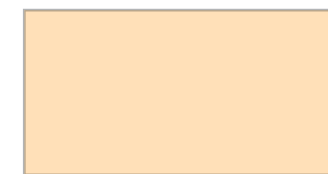
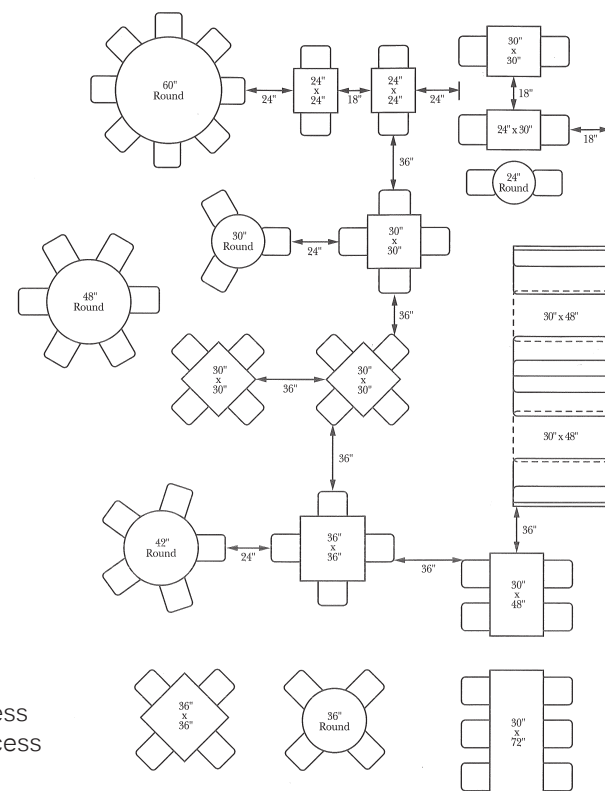

RECTANGLE

18"x24" (2)	30"x48" (4)	42"x72" (6 – 8)
24"x30" (2)	30"x60" (4 – 6)	42"x84" (6 – 8)
24"x36" (2)	30"x72" (6)	42"x96" (8)
24"x42" (4)	30"x84" (6)	48"x96" (8)
24"x48" (4)	30"x96" (8)	48"x120" (10 – 12)
24"x60" (4)	36"x42" (4)	48"x144" (12 – 14)
24"x72" (6)	36"x48" (6)	48"x168" (14 – 16)
24"x84" (6)	36"x60" (6)	60"x120" (12)
24"x96" (8)	36"x72" (6)	60"x144" (14)
30"x36" (2 – 4)	36"x84" (6 – 8)	60"x168" (16)
30"x42" (4)	36"x96" (8)	

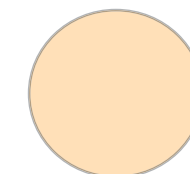

ROUND

18" Round (2)
24" Round (2)
30" Round (2 – 4)
36" Round (4)
42" Round (4)
48" Round (6)
54" Round (7)
60" Round (8)



SQUARE

18"x18" (2)
24"x24" (2)
30"x30" (2 – 4)
36"x36" (4)
42"x42" (4)
48"x48" (6)

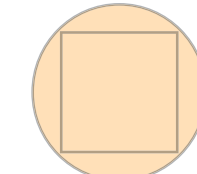

DROP LEAF

42" Round to 30"x30" (2 – 5)
48" Round to 34"x34" (2 – 5)
51" Round to 36"x36" (2 – 5)
60" Round to 42"x42" (2 – 5)

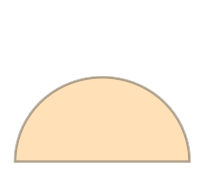

HALF CIRCLE

24"x48" (2)
30"x60" (2)
36"x72" (2 – 4)



OVAL

24"x36" (2)	24"x96" (8)	30"x96" (8)
24"x36" (2)	30"x36" (2 – 4)	36"x72" (6 – 8)
24"x42" (4)	30"x42" (4)	42"x54" (4 – 8)
24"x48" (4)	30"x48" (4)	42"x78" (6 – 8)
24"x60" (4)	30"x60" (4 – 5)	42"x84" (6 – 8)
24"x72" (6)	30"x72" (6)	48"x78" (6 – 8)
24"x84" (6)	30"x84" (6)	48"x96" (8)



ARC RECTANGLE

30"x60" (6)	42"x84" (6 – 8)
30"x72" (6 – 8)	42"x96" (8)
30"x84" (6 – 8)	48"x96" (8)
30"x96" (8)	48"x120" (10 – 12)
36"x60" (6)	48"x144" (12 – 14)
36"x72" (6 – 8)	48"x168" (14 – 18)
36"x84" (6 – 8)	60"x120" (12)
36"x96" (8)	60"x144" (14)
42"x72" (6 – 8)	60"x168" (16)



RACETRACK

30"x60" (6)	42"x84" (6 – 8)
30"x72" (6 – 8)	42"x96" (8)
30"x84" (6 – 8)	48"x96" (8)
30"x96" (8)	48"x120" (10 – 12)
36"x60" (6)	48"x144" (12 – 14)
36"x72" (6 – 8)	48"x168" (14 – 18)
36"x84" (6 – 8)	60"x120" (12)
36"x96" (8)	60"x144" (14)
42"x72" (6 – 8)	60"x168" (16)



BOAT

36"x72" Center 42 (6 – 8)
36"x84" Center 48 (6 – 8)
36"x96" Center 48 (6 – 8)
36"x120" Center 48 (6 – 8)
36"x144" Center 48 (6 – 8)
36"x168" Center 48 (6 – 8)

(#) Denotes seating capacity

Seating



Providing comfortable, spacious seating for your diners to relax is very important to the success of your establishment. The following guidelines lay forth seating layout standards for booths and tables to create a pleasant seating environment for your guests. At Soft Touch Furniture, our furniture always meets these guidelines, which helps ensure your guests feel comfortable in your establishment. As always, check with your local codes to see if there are any special spacing requirements.

Bar



If your restaurant is to have a bar or a counter space that diners will eat or drink at the layout of that area is just as important as regular tables and booths. Below are the standards for bar and counter designs that allow for a well proportioned space. Remember that not only will your guests need to feel comfortable visiting your establishment, your staff will need to be comfortable working in the environment as well. Making sure that the staff has adequate workspace is very important to how your establishment will run and the working atmosphere you create.

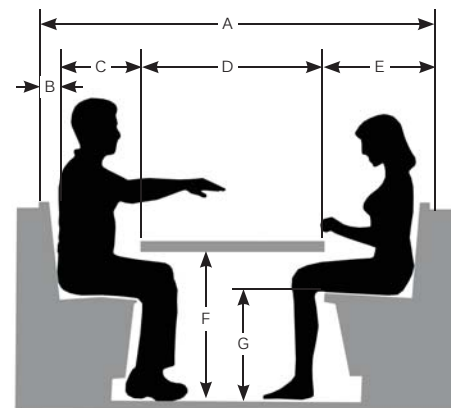

BOOTH DIMENSIONS

- A. Total booth width 66" – 84"
- B. Seat back depth 3" – 6"
- C. Seat back-to-table edge clearance 16"
- D. Table width 24" – 42"
- E. Table edge to back of seat cushion 22" – 24"
- F. Tabletop height 29" – 30"
- G. Seat height 18" – 19 1/2"

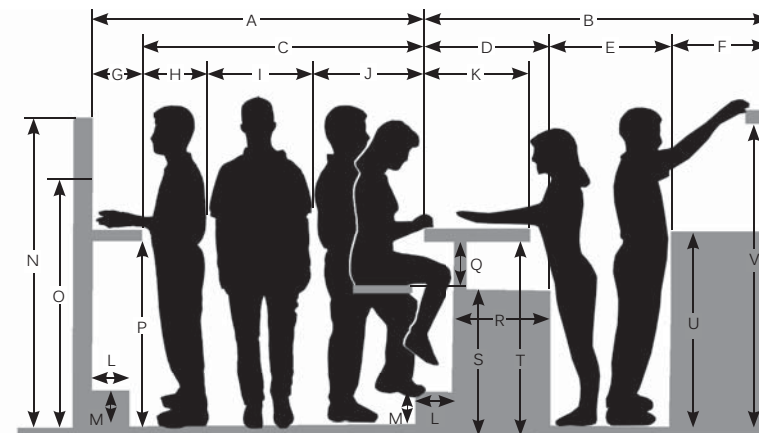

BAR DIMENSIONS

- A. Outer bar edge to wall 76" – 84"
- B. Outer bar edge to back wall 84" – 104"
- C. Outer bar edge to drinking shelf 66" – 72"
- D. Outer bar edge to equipment edge 23" – 28"
- E. Behind bar traffic area 30" – 36"
- F. Back bar depth 24" – 30"
- G. Drinking shelf depth 10" – 12"
- H. Drinking shelf customer area 18"
- I. Customer traffic area 30"
- J. Bar seating area 18" – 24"
- K. Bar depth 18" – 24"
- L. Footstep depth 6" – 9"
- M. Footstep height 7" – 9"
- N. Room divider screen (high) 76"
- O. Room divider screen (low) 55"
- P. Drinking shelf height 42" – 45"
- Q. Top of barstool to bottom of bar 11" – 12"
- R. Depth of behind-bar equipment 22" – 26"
- S. Behind-bar equipment height 30"
- T. Bar height 42" – 45"
- U. Back bar height 36" – 42"
- V. Back wall shelf height 60" – 69"

TABLE DIMENSIONS

- A. Total area required for table 60" – 90"
- B. Tabletop width 24" – 42"
- C. Customer traffic and seating area 54" – 72"
- D. Customer seating area 18" – 24"
- E. Traffic area 18" – 36"
- F. Tabletop height 29" – 30"
- G. Seat height 16" – 18"

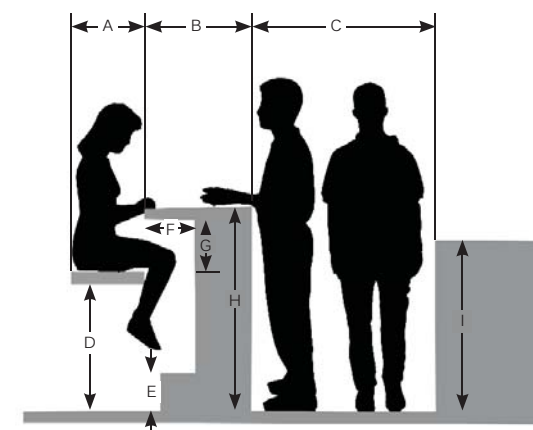
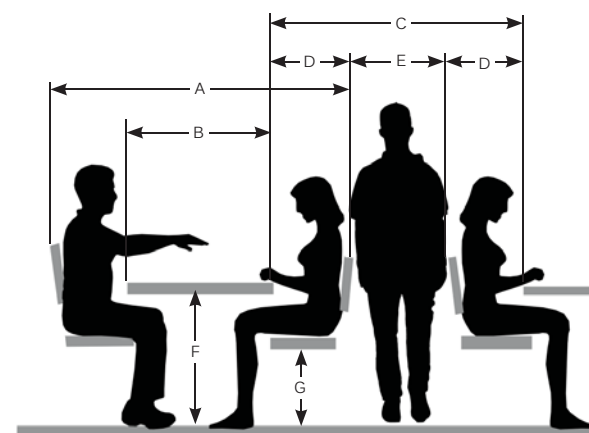

COUNTER DIMENSIONS

- A. Customer seating area 12" – 18"
- B. Counter depth 18" – 24"
- C. Service traffic area 36"
- D. Seat height 30" – 31"
- E. Footstep height 12"
- F. Depth of counter underside 10"
- G. Top of seat to underside of counter 11" – 12"
- H. Counter height 42"
- I. Back service counter height 36"

ADA

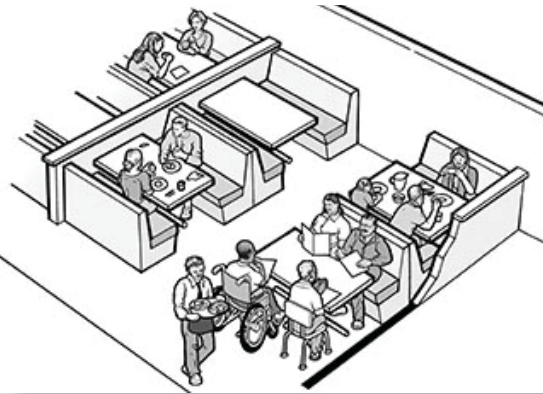

One thing a lot of people forget about when designing a restaurant is accessibility for the disabled in terms of dining comfort. Your restaurant may have ramps, handicap accessible bathrooms, and parking spaces, but there is more to making a space accessible to the disabled. Below are the standards for designing with regards to ADA regulations for access to tables.

ADA RECOMMENDED CLEARANCES

To comply with ADA regulations for wheelchair access to tables please use these recommended specifications:

- Minimum clearance of 27" from the floor to the bottom of the table
- Minimum barrier free width of 30"
- Minimum barrier free depth of 19"
- Minimum unobstructed space from tale edge of 30"
- Overall table height not to exceed 34"

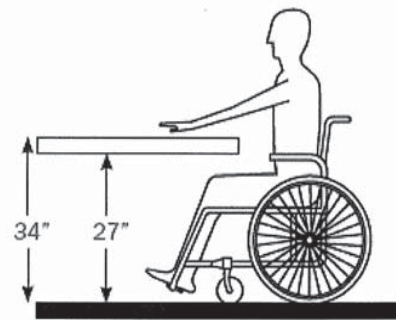

ADDITIONAL ADA RESOURCES

- National Network of ADA Centers: www.adata.org
- U.S. Justice Department's ADA Side: www.ada.gov
- ADA and ABA Guidelines: www.access-board.gov/ada

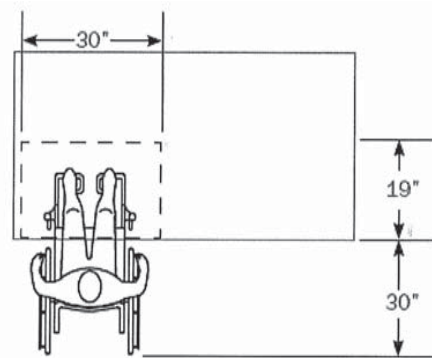

Spacing

The spacing between booths and barstools influence your customers' dining experience. Too much space makes your customers feel disjointed. Too little space makes your customers feel claustrophobic. Use the booth and barstool spacing guidelines below to keep your customers feeling comfortable. Another thing to keep in mind when thinking about your booths is the booth table base. You can use a standard base on booth tables, but a great option to give your customers extra leg room are the cantilever bases featured below.



BOOTH SPACING AND LENGTHS

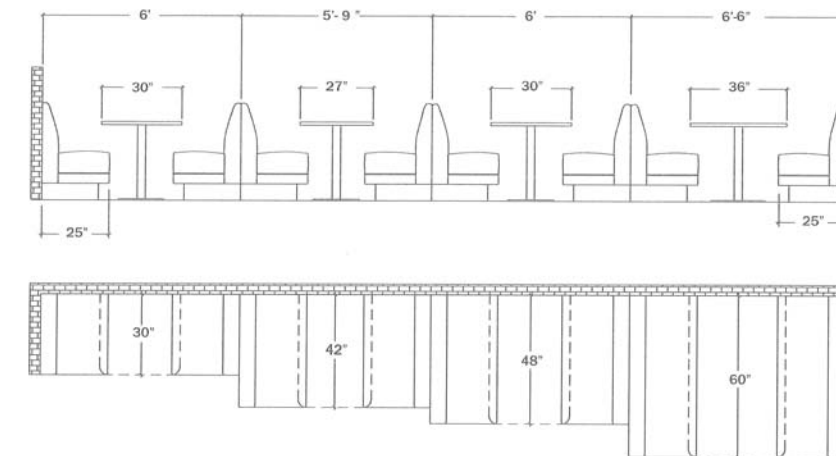

BARSTOOL SPACING

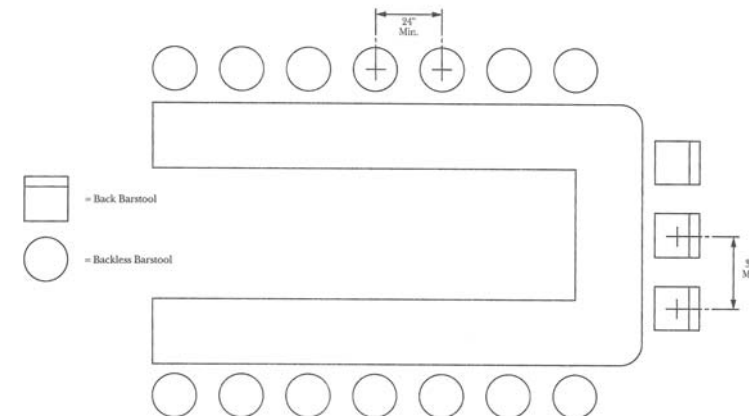

BOOTH BASE OPTIONS

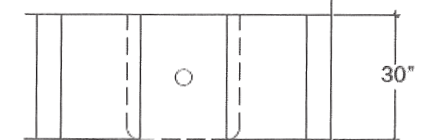

30" BOOTH STANDARD BASE

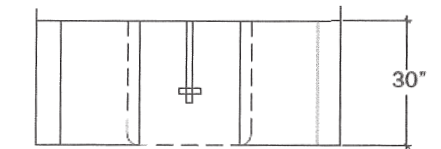

30" BOOTH CANTILEVER

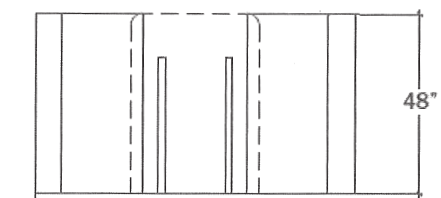

48" BOOTH CANTILEVER

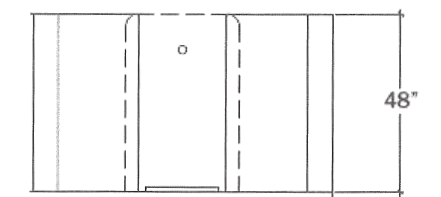

48" TABLE LEG WITH WALL CLEFT

Booth Shape

The shape of your furniture can greatly affect the way your establishment looks and functions. There are many different shapes of booths available to customize your design. The most common booth shapes are the single and double booths; however mixing shapes can give your space a unique look. The booth shapes below can be mixed and matched to your desire, but also remember that custom shapes are available if none of these work for you.

Things to take note of in your space when deciding which booth shapes you want to use

- Location of all windows and doors
- Tight corners or small spaces
- Angled or curved walls
- Columns
- Long lengths of wall
- Any accessibility issues



SINGLE



DOUBLE



U-SHAPE



3 QUARTER



STRAIGHT



L-SHAPE



ROTUNDA

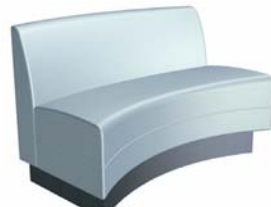

ELLIPSE

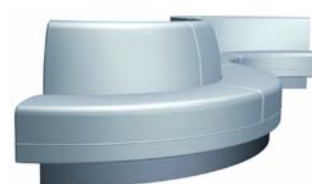

CUSTOM CURVE

Height

There are several different height options for tables, chairs, and booths. As the height of your furniture can greatly affect the feel of your establishment, there are things to keep in mind when choosing the height of your furniture: What atmosphere do you want to have (casual vs. formal)? Are there any regulations that you need to be aware of? Are there any architectural features of your space which may help determine the size of your furniture (lower ceiling, etc.)? Once you answer these questions choosing the size of your furniture should be easy.

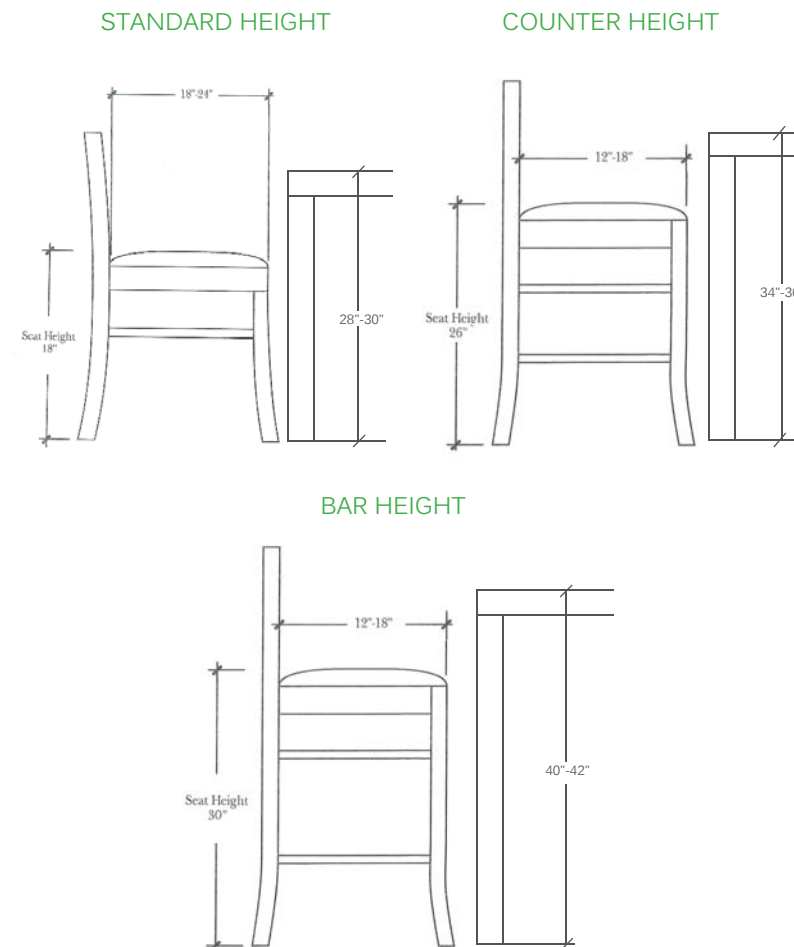

DIFFERENT HEIGHT CHOICES

- **Standard Height:**
 This is typically a table height of 28" – 30" and a seat height of 18". It is the most common height in restaurants. Not only do most people find this height very comfortable, it is also the only height that complies with ADA regulations.
- **Counter Height:**
 This is typically a table height of 34" – 36" and a seat height of 26". They are typically more casual and make it easier to talk with people who may be standing. They can work well in small areas because they give the illusion that they take up less space.
- **Bar Height:**
 This is typically a table height of 40" – 42" and a seat height of 30". This taller, thinner height is very good for small spaces (and perfect for "bar area" tables). They have the same advantages as counter height furniture but even more so. And because the difference between standing and sitting is so minimal, they create an extremely casual, "fun" atmosphere.

Example



Below are some examples of different layout options that are available. There are thousands of different combinations, so these are just the tip of the iceberg (let your creativity run wild!) When designing your space, you will want to make sure that the design has the number of seats you desire, the atmosphere you wish, while also making your customers comfortable.

Space



Remember that every space can be unique, no matter how regular or irregular it may be. Different layouts create different atmospheres, which allow for very different experiences. When laying out your space, make sure you're not only thinking about the overall floor plan, but also considering the height you want your diners to be sitting at. Having seating areas that are at different heights can make your space much more dynamic, and allow many different experiences within a single area.

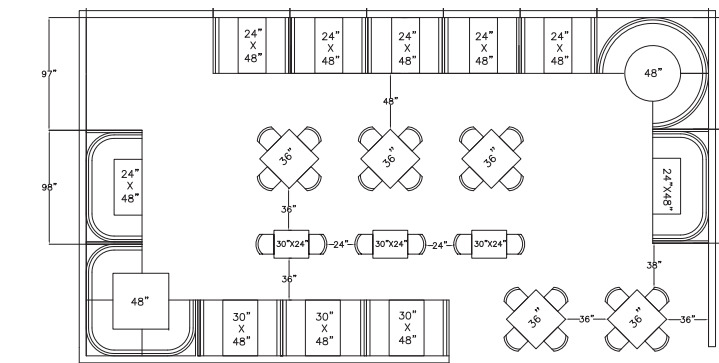
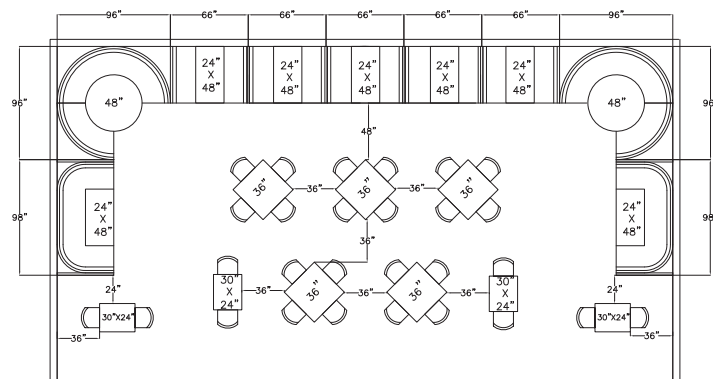
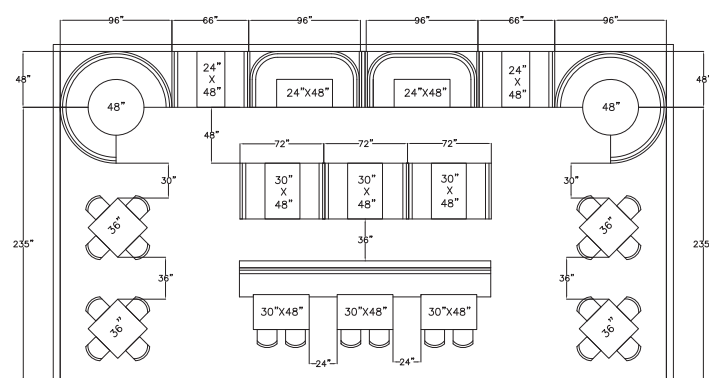
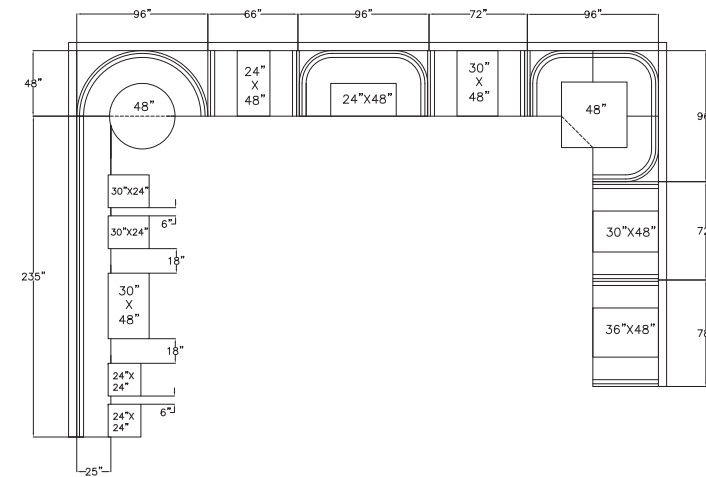
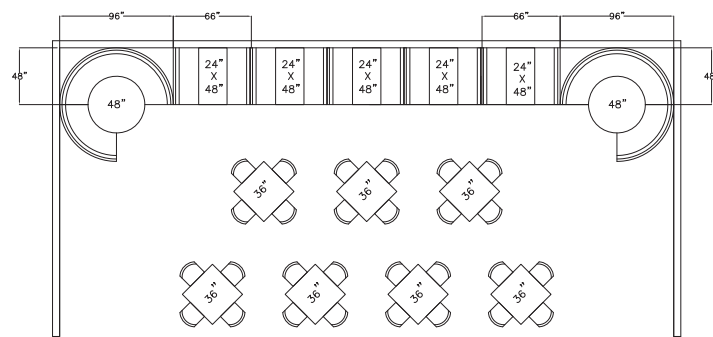
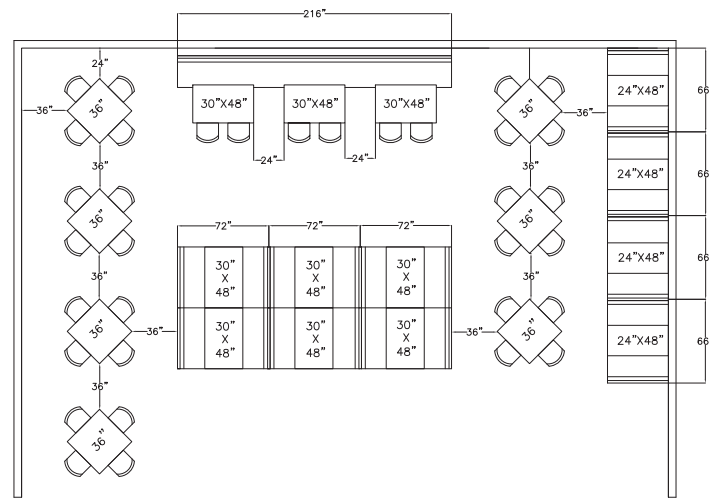

THINGS TO CONSIDER WHEN DESIGNING YOUR SPACE

- Organize seating so your staff has a clear path between each table and the kitchen.
- For busy aisles with bidirectional traffic (both servers and customers), consider a wider aisle.
- Leave clear paths to fire exits. In the event of an emergency, guests must be able to escape. If you're unsure whether your seating plan is safe, consult the local fire marshal.
- Think about your desired customer base. Different groups of people feel more comfortable in different settings. Casual, formal, a mix of the two – what's your vision?
- Remember it's your space. There are thousands of options for designing it, so you can be as creative as you want.
- When in doubt, ask for help. At Soft Touch Furniture, we are happy to help with the designing of your space, and we will work with you to make sure your vision is realized.

Fabric



Designing your space involves a lot more after the initial layout phase. Fabric choices greatly affect the look and feel of everything. When selecting your materials, keep in mind it's more than physical appearance. Fabric can have different durability characteristics, and can be designed different ways. Use the following guide to choose the fabric for your furniture.

FABRIC DESIGN

- Fabric designed to be applied the "regular" way has the pattern or grain running vertical (up the roll.) The top of the design will be perpendicular to the edge of the roll.
- Fabric designed to be railroaded has the pattern running horizontal (along the roll.) The top of the design will be parallel to the edge of the roll. This type of fabric is typically used when the width of the fabric is not enough to run the whole length of the piece of furniture.
- All fabrics typically have patterns that will repeat after a certain length. The term "repeat" refers to the length of the pattern before it starts over. Normally the repeat in the fabric will be in increments of 3", with the largest repeat typically being 27". Repeats can be vertical, horizontal, or in both directions.

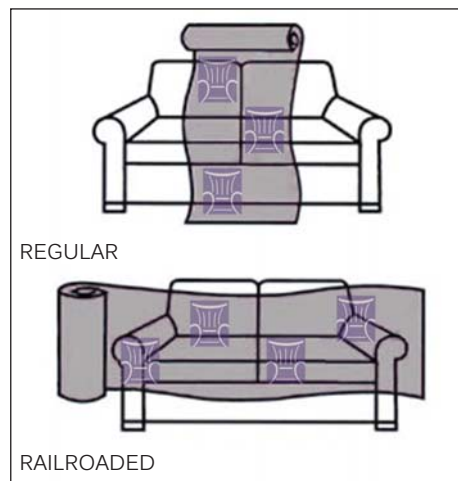

FABRIC DURABILITY

Fabric durability is typically measured by what's called a double-rub count. This testing method is done using a machine that rubs a pad back and forth until the fabric is worn. Each back and forth pass is known as a "double-rub." Different grades of fabric require a different double-rub count.

- Heavy-duty commercial grade fabrics will withstand 100,000 double-rubs or more, and are durable enough for a high traffic commercial area.
- Heavy-duty grade fabrics will withstand 30,000 double-rubs. This fabric grade is generally stiffer and thicker than regular fabric and can be used in high traffic residential areas.
- Medium-duty grade fabrics will withstand between 15,000 and 30,000 double-rubs. This fabric grade is versatile and can be used for residential usage in moderate traffic areas.
- Light-duty grade fabrics will withstand between 9,000 and 15,000 double-rubs. This fabric grade generally only withstands one to three years of regular usage, and is not recommend for upholstery work.
- Delicate-duty grade fabrics will withstand under 9,000 double-rubs. This fabric grade should only be used for decorative applications.

Foam and Cleaning

How long your furniture last depends a lot on what you put in and on it. In a booth or seat cushion the density of foam you choose can affect the longevity of the piece. Likewise, how well you care for your furniture can affect how well it holds up over time.



FOAM

Foam can be measured by density and firmness (these are separate characteristics – e.g., you can have a very dense foam that is also very soft or you could have a very firm foam that is not very dense.) Because of this, it is possible to pick foam that will suit any need imaginable. Below are the characteristics of these two values.

DENSITY:

- Density measures foams longevity and quality.
- It is dictated by the size and thickness of the individual cells that make up the foam.
- Foams density is measured by how much one cubic foot of the material weighs. For example one cubic foot block of 3 lb. foam will weigh 3 lbs.
- The denser the foam, the higher the quality and the longer the foam will last.

FIRMNESS:

- Firmness measures the physical feel of foam and how it resists pressure.
- It is measured by seeing how much pressure, in pounds, it takes to compress a 15" by 15" by 4" sample of foam one inch with a 50 square inch circular indenter.
- The value of that amount is called an ILD.
- Firmer foam has a higher ILD while softer foam has a lower ILD.
- Most ILD values range from 8 to 70 but can go as high as 150.

CLEANING INFORMATION

DC	<ul style="list-style-type: none"> ■ Dry clean ONLY
S	<ul style="list-style-type: none"> ■ Spot clean only with a water-free cleaning solvent ■ Do not saturate or use water ■ When cleaning a spill blot immediately to remove spilled material
W-S	<ul style="list-style-type: none"> ■ Spot Clean with upholstery shampoo, foam from a mild detergent or a mild dry cleaning solvent ■ Do not saturate
W	<ul style="list-style-type: none"> ■ Spot clean only with a water based shampoo or foam upholstery cleaner ■ Do not oversaturate or use solvents to spot clean ■ Blot immediately to remove any spilled material
X	<ul style="list-style-type: none"> ■ Clean only by vacuuming or light brushing with a non-metallic stiff bristle brush ■ Do not use water or solvent based cleaner
Leather	<ul style="list-style-type: none"> ■ The most easy to care for material ■ Use normal dusting and occasional mild soap and damp cloth ■ Never wax, polish, or oil
Vinyls	<ul style="list-style-type: none"> ■ Make sure you protect vinyls from hair and body oils ■ Wash with warm water and mild soap
Crypton	<ul style="list-style-type: none"> ■ Crypton has special cleaning instructions ■ View www.cryptoncare.com for instructions
Flock Fabrics	<ul style="list-style-type: none"> ■ Spot clean only with a water based shampoo or foam upholstery cleaner ■ Do not over wet or use solvents to spot clean ■ Use cautious agitation or rubbing while fabric is damp as flock fabrics are sensitive to pile distortion and texture change with too much agitation ■ Use extreme caution if using a professional cleaning service ■ Allow to dry at least 24 hours before use after cleaning

Design

We hope this design guide is helpful in designing your own space. That said, we realize designing is not easy, and can actually seem overwhelming. That's why we offer our own design services, which are here to help you any way we can. Whether you just need us to check over your own work, or you want us to design the space from the ground up (including choosing fabrics and finishes), we can help as much or as little as you need.

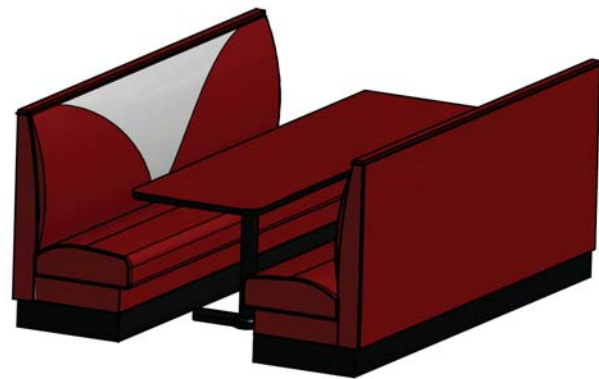

DESIGN SERVICES

- Project consultation
- Overview of your design concept
- Field measurements
- Seating plan with 2D CAD drawings
- Assistance with choosing style and fabrics
- Fabric and finish samples available
- 3D renderings
- Wall elevations
- Delivery of final product
- Installation

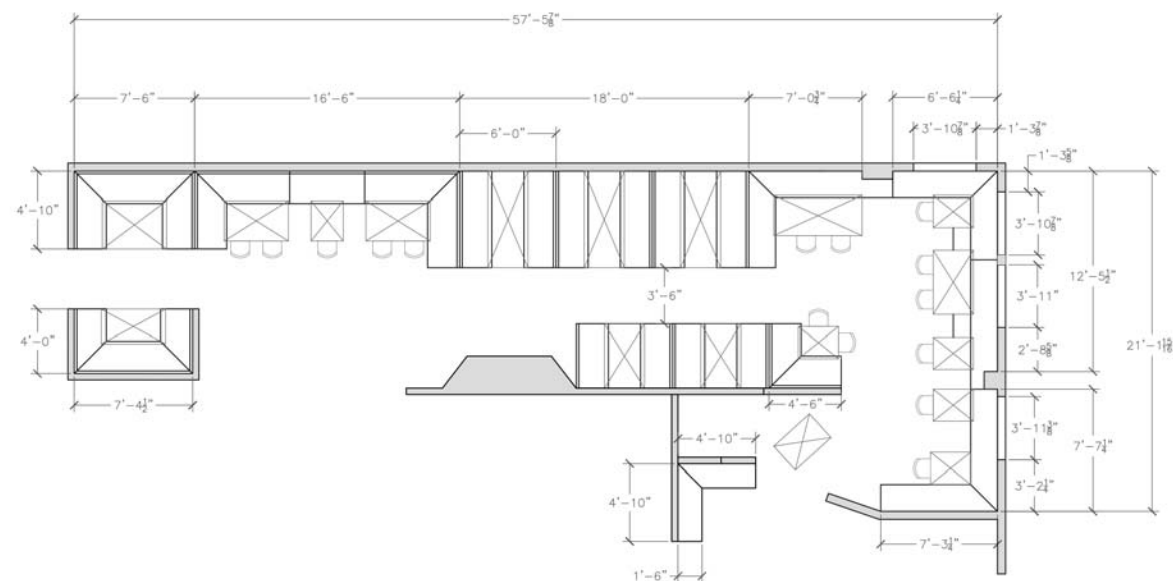

FIRE CODES

Please check with your local fire marshall if needed, for your specific fire code needs

FABRIC FIRE CODES

UFAC UPHOLSTERED FURNITURE ACTION COUNCIL

This test is often referred to as the Cigarette Test because the purpose is to classify the fabric on its propensity to resist cigarette ignition when tested in combination with a standard foam cushioning material. The candidate fabric is used to cover small pieces of a standard foam cushioning material. The test pieces (fabric over the foam) are placed on a small test rig, simulating a chair back and seat. A lighted cigarette is placed in the crevice where the back and the seat of the chair meet. To intensify the heat, the cigarette is covered by a piece of cotton sheeting fabric. This test records the extent of the vertical burning (char length) on the back section of the seat assembly and whether or not ignition occurred.

CALL 117 CALIFORNIA TECHNICAL BULLETIN 117 SECTION E (CS191-53)

The California Technical Bulletin 117, Section E requires testing in accordance with the same procedure as CS 191-53. Using this method, a 2" X 6" specimen is placed into the tester situated at a 45 degree angle. The surface of the test specimen is touched by a 5/8" long pencil-thin flame for a period of 1 second. The rating criteria is either "Pass" (did not ignite) or "Fail" (ignites).

NFPA 260

Standard Methods of Tests and Classification System for Cigarette Ignition Resistance of Components of Upholstered Furniture

NFPA 701 SMALL SCALE STANDARD FOR FLAME TESTS OF TEXTILES

Draperies, blankets, bedspreads, quilts, mattress ticking, sheets, upholstery fabrics, wall hangings, outside coverings. This recently revised test places the fabric specimen in a vertical position while a test flame is held to the lower edge for 12 seconds before the flame is removed. The test requires that any after-flame must be extinguished within 2 seconds of the removal of the test flame, that no flaming drippings touch the test chamber floor, and that the char length be limited according to the weight of the fabric.

NFPA 701 VERTICAL BURN

12 second ignition, sample size 3 1/2" X 10", maximum flame time 2 seconds, maximum burn length specified, no drop to floor.

FOAM FIRE CODES

CAL 117 CALIFORNIA TECHNICAL BULLETIN 117, SECTION E (CS 191-53)

This test is conducted under specific laboratory conditions. The result cannot be used as a demonstration of the performance of furnishings containing California 117 foam in flammability tests nor in actual fire conditions. Foam is tested without any contaminants, including adhesives. It is important to note that all flexible polyurethane foams will burn if exposed to a sufficiently intense heat source. Some of the combustion characteristics of flexible polyurethane foams can be altered by varying formulations and including flame retardants and other additives in production. However, all flexible polyurethane foams, whether they contain flame retardants or not should be considered and handled accordingly

MISCELLANEOUS FIRE CODES

FAR 25.853 (b)

Aircraft: floor covering, draperies, seat cushions, upholstery, padding, decorative, and non-decorative coated fabrics, etc

MVSS #302 MOTOR VEHICLE STANDARD

This protocol currently is in use by the automotive industry for fabrics used in vehicles. The fabric is placed in a horizontal position and allows the test flame to burn at one end. As the fabric burns away from the test flame it is gradually relieved of the heat and combustion front until within a distance of 1 1/2" from the flame. The test measures flame spread from a point 1 1/2" from the flame to 11 1/2" from the flame. Any flame spread that is 4" per minute or less is acceptable.

MVSS #302 HORIZONTAL BURN

Sample size 4" X 14", maximum 4" per minute burn rate.

For additional information on our products including: installation, quotes, warranty, and pricing, give us a call. We'll be glad to help—877.747.7638

softtouchfurniture.com



Have questions or interested in learning more? Feel free to contact us!

Address
1560 South State Street
Girard, OH 44420
USA

Phone
877.747.7638
330.545.4204

Fax
330.288.0083

Email
info@softtouchfurniture.com

Interested in other aspects of Soft Touch Furniture? See our other brochures



Tabletops & Bases

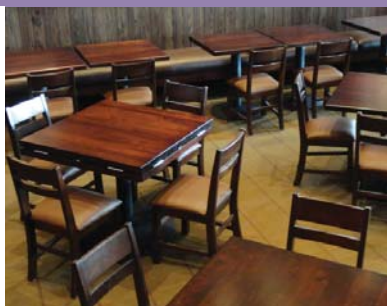

Chairs



Interiors



Booths, Banquettes,
& Interiors

A FINAL WORD

We hope you've found this brochure informative, and that it's given you an insight on not just how to design your restaurant, but the way we conduct business as well. Because in this hustle-bustle change-a-minute world, it's reassuring to find a company that delivers what it promises, and does so with a personal touch that seems to be a lost art today.

When you call us, you talk to real people who are focused on meeting your restaurant and hospitality furniture needs. Whether you own one establishment or are the buyer for a large chain, you can expect nothing less than our full attention and, most importantly, our very best work. Oh, and the cherry on top is we'll do it at a price that you'll love. High quality, American-made beauty does not have to break the bank. Yes, you can have it all. Get in touch with us today and prepare to be pleasantly surprised.

At Soft Touch Furniture we also believe in giving back to the community. We contribute to several charities including Alex's Lemonade Stand. For more information on contributing to Alex's Lemonade stand go to <http://www.alexslimonade.org>.

