

Waste Receptacles and Custom Millwork:

HOSTESS AND RECEPTION DESKS TO CONDIMENT AND SERVICE STATIONS



Functional, Stylish,
and Built to Last.
We Make Garbage
Look Good!



WE ARE THE MANUFACTURER

WHAT MAKES US DIFFERENT

We have been a leader in the commercial furniture industry for over 40 years—manufacturing durable commercial furniture with a strong reputation for affordable quality custom products. We have an uncompromising commitment to quality products with a steadfast focus on getting our clients, both small and large, exactly what they want.

We are proud of our excellent customer service—we know that your project demands our special attention. When you partner with Soft Touch Furniture, you receive expert knowledge, personal attention, and competitive pricing—a combination that sets us apart in the industry.



See page 19 for full description



Lets Talk Trash!!

We're half kidding, but yes, waste receptacles are important. In fact, for many establishments, they are the last fixture a customer interacts with before leaving. And your millwork's look and functionality is important to customers and employees both.

Our waste receptacles and millwork are built with the same attention to detail as the rest of our fine furniture:

- Quality materials, and American-made craftsmanship. Easy-to-use swing doors, drop holes, and cabinet doors.
- Large storage areas for trays and dishes.
- Attractive engraved lettering.
- A myriad of color, laminate, trim, and finish options.
- The extras, like magnets for doors, high quality glides and casters, and more.
- For millwork, we can custom build you just about anything.

Take a look at the designs in this catalog, and if we can help you in any way, give us a call.



SOFTTOUCHFURNITURE.COM | 1.877.747.7638

Single Waste Receptacle with Flap Front

Model: SFT-231

STANDARD FEATURES

- Swing door with permanently routed black or white filled letters or images
- Continuous piano hinge
- Heavy-duty magnetic access door
- Choice of high-pressure decorative laminate from: Wilsonart, Formica, Nevamar, or Pionite with self edge
- Heavy-duty nickel plated steel swinging door hinge
- Interior finished with thermo-fused black melamine
- Chrome leveling glides for easy mobility
- Bottom shelf is stainless steel lined for easy cleaning and sanitation

OPTIONAL FEATURES

- 35-Gallon capacity trash liner: large, gray, square, durable, crack resistant, molded plastic construction
- Casters for easy mobility (adds 2½" to height)

RECEPTACLE DIMENSIONS

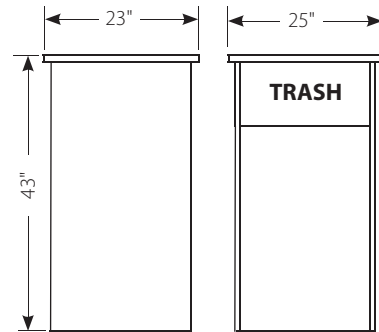

FINISHING TOUCHES



Continuous piano hinge



Engraved lettering



Bottom shelf is stainless steel lined



Heavy-duty nickel plated steel swinging door hinge

Double Waste Receptacle with Flap Front

Model: STF-232

STANDARD FEATURES

- Swing door with permanently routed black or white filled letters or images
- Continuous piano hinge
- Heavy-duty magnetic access door
- Choice of high-pressure decorative laminate from: Wilsonart, Formica, Nevamar, or Pionite with self edge
- Heavy-duty nickel plated steel swinging door hinge
- Interior finished with thermo-fused black melamine
- Chrome leveling glides for easy mobility
- Bottom shelf is stainless steel lined for easy cleaning and sanitation

OPTIONAL FEATURES

- 35-Gallon capacity trash liner: large, gray, square, durable, crack resistant, molded plastic construction
- Casters for easy mobility (adds 2½" to height)

RECEPTACLE DIMENSIONS

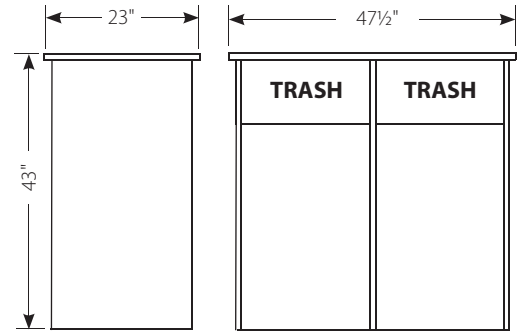

Also Available in Triple (3) Unit (STF-233) and Quadruple (4) Unit (STF-234)



FINISHING TOUCHES

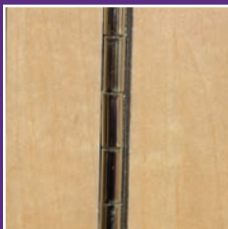

Continuous piano hinge



Heavy-duty swing door hinge



Bottom shelf is stainless steel lined



Heavy-duty magnetic access door

Single Waste Receptacle with Flap Front and Tray Shelf

Model: STF-241

STANDARD FEATURES

- Swing door with permanently routed black or white filled letters or images
- Continuous piano hinge
- Heavy-duty magnetic access door
- Choice of high-pressure decorative laminate from: Wilsonart, Formica, Nevamar, or Pionite with self edge
- Heavy-duty nickel plated steel swinging door hinge
- Chrome leveling glides for easy mobility
- Bottom shelf is stainless steel lined for easy cleaning and sanitation
- Top of unit has tray shelf

OPTIONAL FEATURES

- 35-Gallon capacity trash liner: large, gray, square, durable, crack resistant, molded plastic construction
- Casters for easy mobility (adds 2½" to height)

RECEPTACLE DIMENSIONS

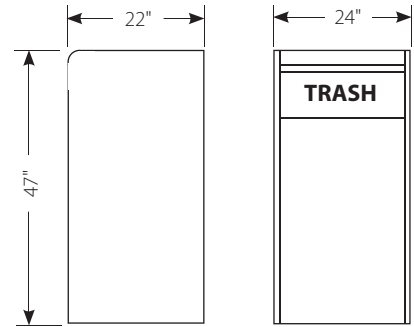

Also Available in Double (2) Unit (STF-242), Triple (3) Unit (STF-243) and Quadruple (4) Unit (STF-244)



Continuous piano hinge



Heavy-duty swing door hinge



Bottom shelf is stainless steel lined



Heavy-duty magnetic access door

Single Top Drop Waste Receptacle

Model: STF-251

STANDARD FEATURES

- Choice of high-pressure decorative laminate from: Wilsonart, Formica, Nevamar, or Pionite with self edge
- Continuous piano hinge
- Heavy-duty magnetic access door
- Chrome leveling glides for easy mobility
- 8" Diameter polished stainless steel drop hole. Additional drop hole sizes available: 6", 10", 12"
- Wire pull handle
- Bottom shelf: stainless steel lined for easy cleaning and sanitation

OPTIONAL FEATURES

- Engraved lettering—white or black
- 35-Gallon capacity trash liner: large, gray, square, durable, crack resistant, molded plastic construction
- Casters for easy mobility (adds 2½" to height)

RECEPTACLE DIMENSIONS

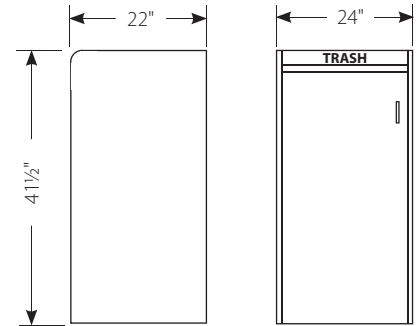

FINISHING TOUCHES



Continuous piano hinge



Engraved lettering and 8" drop hole



Wire Pull Handle



Heavy-duty magnetic access door

Busing and Recycling Station

Model: STF-351

STANDARD FEATURES

- Choice of high-pressure decorative laminate from: Wilsonart, Formica, Nevamar, or Pionite with self edge
- Continuous piano hinge
- Heavy-duty magnetic access door
- Chrome leveling glides for easy mobility
- 4" Diameter black grommet for can / bottle recycling
- Wire pull handle
- Tray shelf and space for bus tub. *Bus tub not included
- Bottom shelf: stainless steel lined for easy cleaning and sanitation

OPTIONAL FEATURES

- Engraved lettering—white or black
- Casters for easy mobility (adds 2½" to height)

RECEPTACLE DIMENSIONS

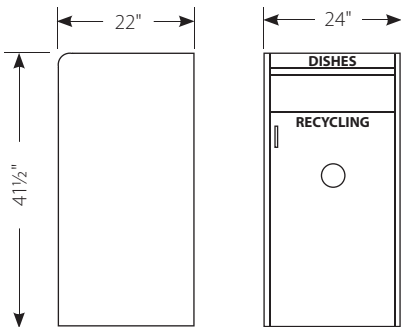

FINISHING TOUCHES



Continuous piano hinge



Wire pull handle and 4" grommet



Bottom shelf is stainless steel lined



Heavy-duty magnetic access door

Double Top Drop Waste Receptacle

Model: STF-252

STANDARD FEATURES

- Choice of high-pressure decorative laminate from: Wilsonart, Formica, Nevamar, or Pionite with self edge
- Continuous piano hinge
- Heavy-duty magnetic access door
- Chrome leveling glides for easy mobility
- 8" Diameter polished stainless steel drop hole. Additional drop hole sizes available: 6", 10", and 12"
- Wire pull handle
- Bottom shelf: stainless steel lined for easy cleaning and sanitation

OPTIONAL FEATURES

- Engraved lettering—white or black
- 35-Gallon capacity trash liner: large, gray, square, durable, crack resistant, molded plastic construction
- Casters for easy mobility (adds 2½" to height)

RECEPTACLE DIMENSIONS

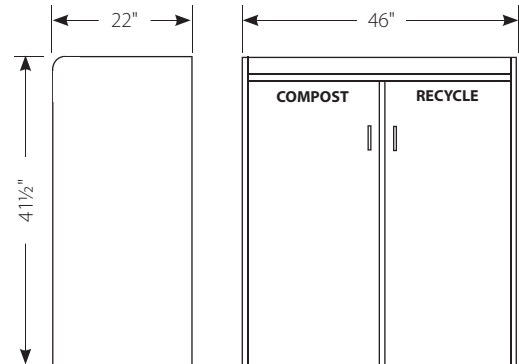

Also Available in Triple (3) Unit (STF-253) and Quadruple (4) Unit (STF-254)



FINISHING TOUCHES

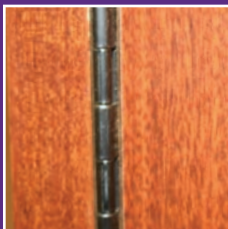

Continuous piano hinge

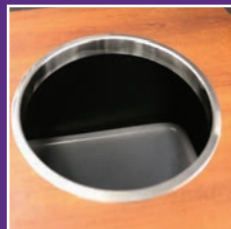

8" Drop hole

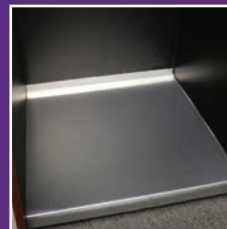

Bottom shelf is stainless steel lined



Heavy-duty magnetic access door

Single Top Drop Waste Receptacle with Storage

Model: STF-2525

STANDARD FEATURES

- Choice of high-pressure decorative laminate from: Wilsonart, Formica, Nevamar, or Pionite with self edge
- Continuous piano hinge
- Heavy-duty magnetic access door
- Chrome leveling glides for easy mobility
- 8" Diameter polished stainless steel drop hole. Additional drop hole sizes available: 6", 10", 12"
- Wire pull handle
- Bottom shelf: stainless steel lined for easy cleaning and sanitation

OPTIONAL FEATURES

- Engraved lettering—white or black
- 35-Gallon capacity trash liner: large, gray, square, durable, crack resistant, molded plastic construction
- Casters for easy mobility (adds 2½" to height)

RECEPTACLE DIMENSIONS

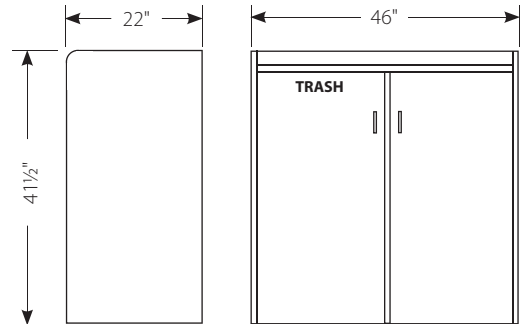

FINISHING TOUCHES

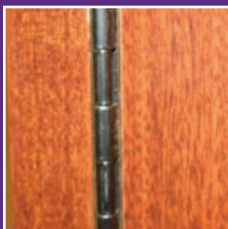

Continuous piano hinge

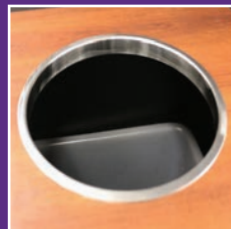

8" Drop hole



Bottom shelf is stainless steel lined



Heavy-duty magnetic access door

Waste Receptacle Options

Functional, stylish, and built to last. We make garbage look good!

Who says trash can't
be attractive and functional?
Not us, that's for sure!

At Soft Touch Furniture, we believe that your trash receptacles are not just an integral part of your establishment's look, but they also contribute to the flow and logistics of your workspace.

We build trash receptacles that look great, and are designed with all the clever little extras.



Single Waste Receptacle

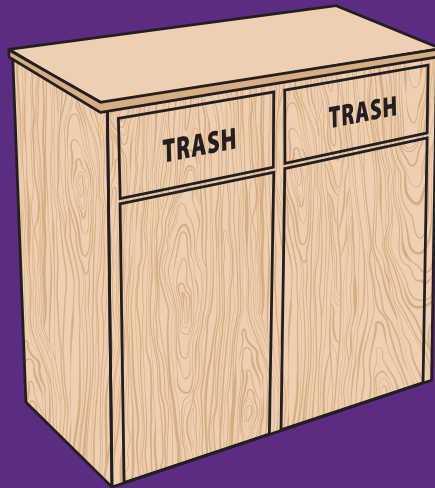

Double Waste Receptacle



Single Waste Receptacle with Storage

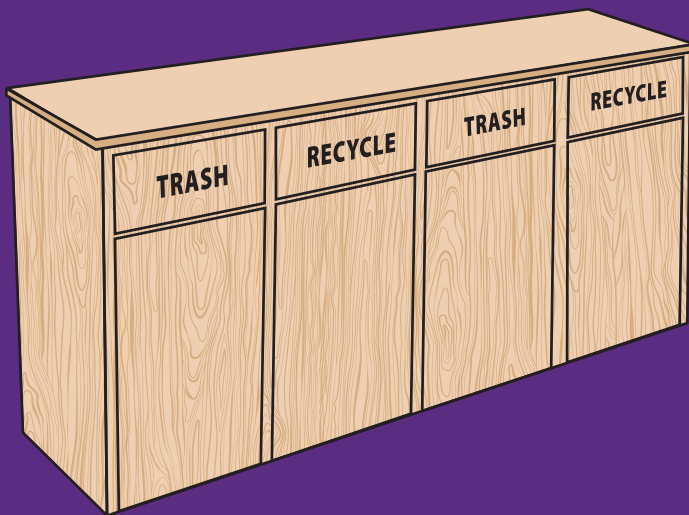

Quadruple Waste Receptacle

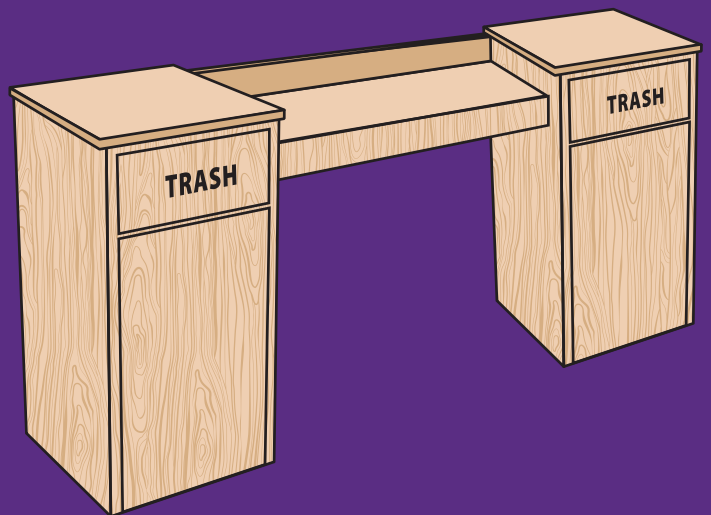

Double Waste Receptacle with Counter and Back Splash

We offer permanently routed lettering to make it clear what the receptacle is used for, continuous pull handles for easy opening, and logically designed drop stations to keep trash areas clean.

No matter what type of receptacle you desire, we have many variations to meet your needs!



Triple Waste Receptacle



Single Waste Receptacle and High Chair Storage



Door Options



Push Door
(Top Only)

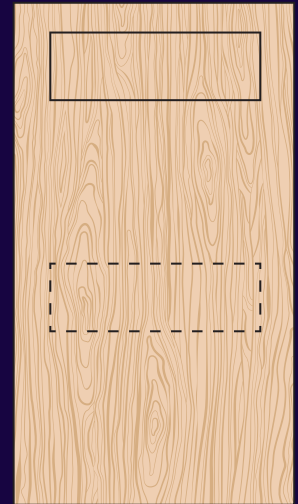

Slot Door
(Specify Top or Bottom)



Round Opening
(Specify Top or Bottom)



No Opening with
Pull Handle

Single Waste Receptacle with Top Drop, Tray Storage, and Bus Tub and Recycling Areas

Model: STF-250

STANDARD FEATURES

- 8" Diameter polished stainless steel drop hole. Additional drop hole sizes available: 6", 10", and 12"
- Continuous piano hinge
- Heavy-duty magnetic access door
- Choice of high-pressure decorative laminate from: Wilsonart, Formica, Nevamar, or Pionite with self edge
- Chrome leveling glides for easy mobility
- Tray shelf and space for bus tub. *Bus tub not included
- Wire pull handle
- 4" Diameter black grommet for can / bottle recycling
- Bottom shelf: stainless steel lined for easy cleaning and sanitation

OPTIONAL FEATURES

- Engraved lettering (or plaques)—white or black
- 35-Gallon capacity trash liner: large, gray, square, durable, crack resistant, molded plastic construction
- Casters for easy mobility (adds 2½" to height)

OPTIONAL FEATURES

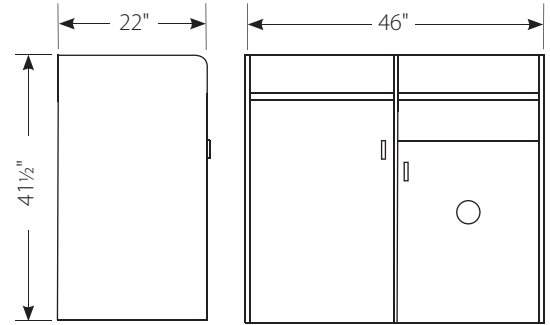

FINISHING TOUCHES



4" Black grommet



Wire pull handle



Continuous piano hinge



8" Drop hole

Single Top drop Waste Receptacle

Model: STF-261

STANDARD FEATURES

- Choice of high-pressure decorative laminate from: Wilsonart, Formica, Nevamar, or Pionite with self edge
- Continuous piano hinge
- Interior finished with thermo-fused black melamine
- Heavy-duty magnetic access door
- Chrome leveling glides for easy mobility
- 8" Diameter polished stainless steel drop hole. Additional drop hole sizes available: 6", 10", and 12"
- Wire pull handle
- Bottom shelf: stainless steel lined for easy cleaning and sanitation

OPTIONAL FEATURES

- Engraved lettering—white or black
- 35-Gallon capacity trash liner: large, gray, square, durable, crack resistant, molded plastic construction
- Casters for easy mobility (adds 2½" to height)

RECEPTACLE DIMENSIONS

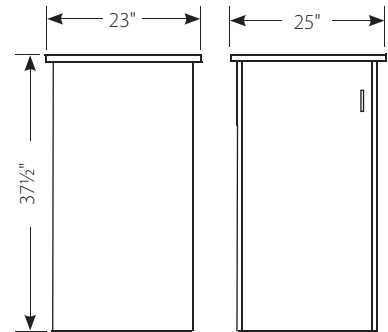

FINISHING TOUCHES

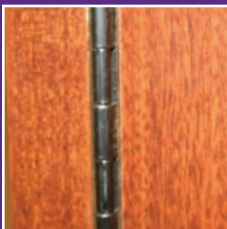

Continuous piano hinge

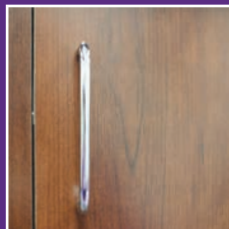

Wire pull handle



Bottom shelf is stainless steel lined



Heavy-duty magnetic access door

Double Top Drop Waste Receptacle

Model: STF-262

STANDARD FEATURES

- Choice of high-pressure decorative laminate from: Wilsonart, Formica, Nevamar, or Pionite with self edge
- Continuous piano hinge
- Interior finished with thermo-fused black melamine
- Heavy-duty magnetic access door
- Chrome leveling glides for easy mobility
- 8" Diameter polished stainless steel drop hole. Additional drop hole sizes available: 6", 10", and 12"
- Wire pull handle
- Bottom shelf: stainless steel lined for easy cleaning and sanitation

OPTIONAL FEATURES

- Engraved lettering—white or black
- 35-Gallon capacity trash liner: large, gray, square, durable, crack resistant, molded plastic construction
- Casters for easy mobility (adds 2½" to height)

RECEPTACLE DIMENSIONS

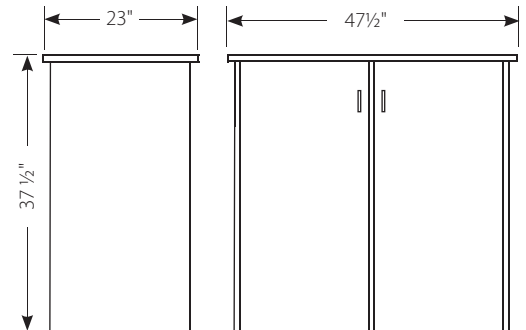

FINISHING TOUCHES

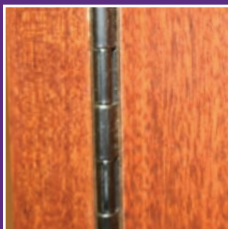

Continuous piano hinge

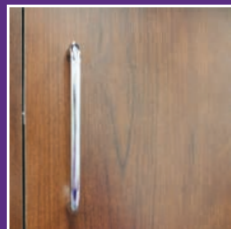

Wire pull handle



Bottom shelf is stainless steel lined



Heavy-duty magnetic access door

Triple Waste Receptacle with Top Drop

Model: STF-263

STANDARD FEATURES

- Choice of high-pressure decorative laminate from: Wilsonart, Formica, Nevamar, or Pionite with self edge
- Continuous piano hinge
- Interior finished with thermo-fused black melamine
- Heavy-duty magnetic access door
- Chrome leveling glides for easy mobility
- 8" Diameter polished stainless steel drop hole. Additional drop hole sizes available: 6", 10", and 12"
- Wire pull handle
- Bottom shelf: stainless steel lined for easy cleaning and sanitation

OPTIONAL FEATURES

- Engraved lettering—white or black
- 35-Gallon capacity trash liner: large, gray, square, durable, crack resistant, molded plastic construction
- Casters for easy mobility (adds 2½" to height)

RECEPTACLE DIMENSIONS

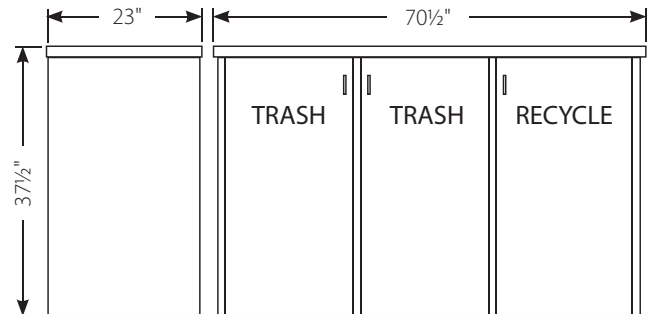

Also Available in Quadruple (4) Unit (STF-264)



FINISHING TOUCHES

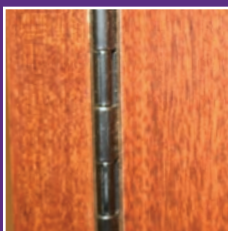

Continuous piano hinge

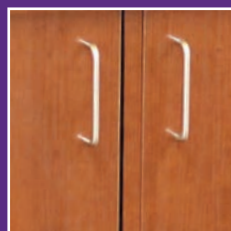

Wire pull handle



8" drop hole



Bottom shelf is stainless steel lined

Single Waste Receptacle with Top Drop and Tray Shelf

Model: STF-210

STANDARD FEATURES

- Hardwood veneer plywood construction; choice of stain colors
- 8" Stainless steel drop hole; additional drop hole sizes available: 6", 10", and 12"
- Heavy-duty Euro-style hinges
- Interior: high pressure laminate; available colors: white or black
- Black laminated kick base
- Tray shelf
- Matching wooden handle
- Chrome leveling glides for easy mobility
- Bottom shelf is stainless steel lined for easy cleaning and sanitation

OPTIONAL FEATURES

- 35-Gallon capacity trash liner: large, gray, square, durable, crack resistant, molded plastic construction
- Casters for easy mobility (adds 2½" to height)

RECEPTACLE DIMENSIONS

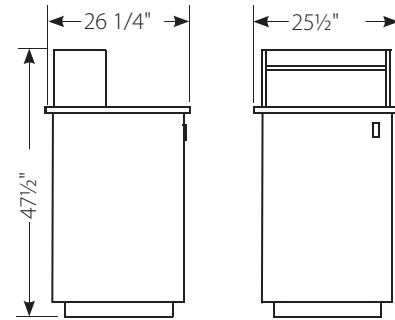

FINISHING TOUCHES



8" Drop hole



Matching wooden handle



Bottom shelf is stainless steel lined

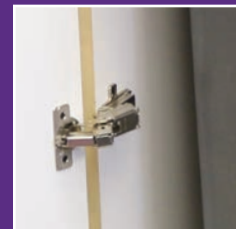

Heavy-duty Euro-style hinges

Custom Millwork—Hostess and Reception Desks to Condiment and Service Stations

Don't see exactly what you want?

That's okay! Simply give us a little information—perhaps even a picture or sketch and we can design a cabinet to suit your needs. Shop drawings are available upon request.



Reception Desk
Model: STF-420



Storage Cabinet
Model: STF-220-S



Condiment and Service Station
Model: STF-360



Condiment and Service Station
Model: STF-365



Condiment and Service Station
Model: STF-325



Condiment and Service Station
Model: STF-340



Condiment and Service Station
Model: STF-345

Open Cabinet
Model: STF-390



AVAILABLE FEATURES

- Any size or shape available
- Premium custom grade construction throughout
- Choice of hardwood plywood or laminated melamine construction
- European hinges
- Spaces for POS systems
- Full extension drawer glides
- Chrome leveling glides for easy mobility
- Wire chases; electrical and data outlets
- Many edge choices available
- Adjustable shelves
- Tops can be made of solid wood, laminate, granite, quartz or other custom materials
- Built to your specifications
- Shop drawings / CNC engineering
- Casters for easy mobility
- Many hardware choices



Trapezoidal Planter with Removable Liner

Model: STF-900

STANDARD FEATURES

- Exterior grade plywood and solid wood construction
- 5" Deep galvanized steel liner with handles for easy removal
- Stainless steel kick base
- Stainless steel corners for protection
- Solid surface cap
- Shown in wood species: hickory



FINISHING TOUCHES



Solid surface top



Galvanized liner has handle for easy removal



Stainless steel kick base

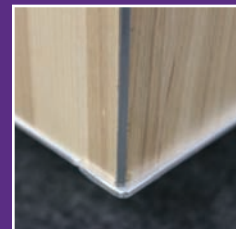

Stainless steel corner protectors



Geometric Planter with Attached Liner

Model: STF-901

STANDARD FEATURES

- CNC engineered exterior grade plywood construction clad in solid surface
- Attached cylindrical galvanized steel liner
- Leveling glides
- Solid Surface options: Avonite, Corian, Wilsonart. Hundreds of color choices available.

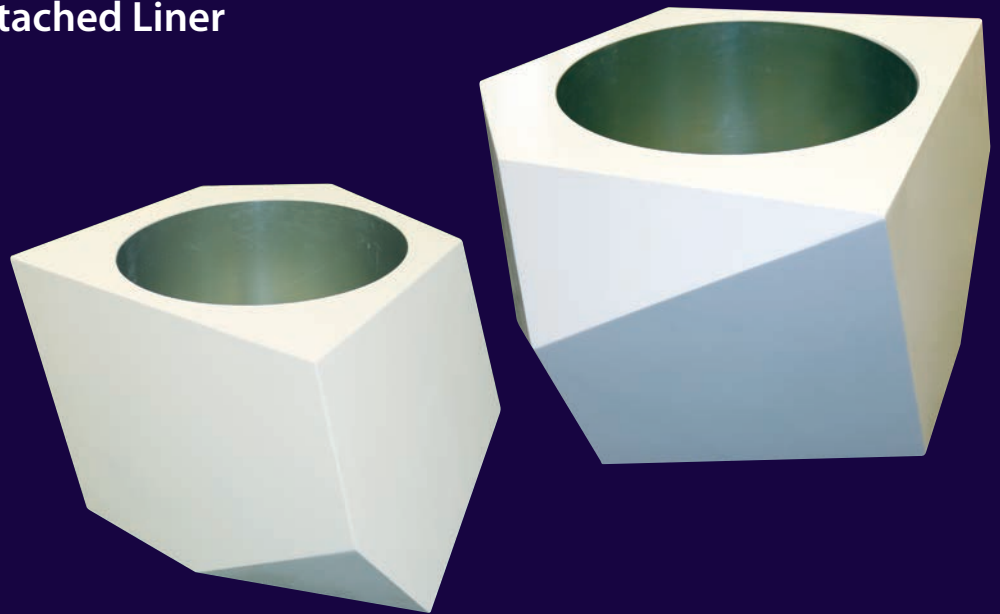

FINISHING TOUCHES



Attached galvanized liner



Leveling glides

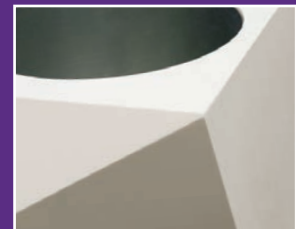

Solid surface exterior with eased edges



For additional information on our waste receptacles and custom millwork including: installation, quotes, warranty, and pricing give us a call. We'll be glad to help—877.747.7638.

A Final Word

We hope you've found this brochure informative, and that it's given you an insight on not just our products, but the way we conduct business as well. In this hustle-bustle change-a-minute world, it's reassuring to find a company that delivers what it promises, and does so with a personal touch that seems to be a lost art today.

When you call us, you talk to real people who are focused on meeting your restaurant and hospitality furniture needs. Whether you own one establishment or are the buyer for a large chain, you can expect nothing less than our full attention and, most importantly, our very best work. Oh, and the cherry on top is we'll do it at a price that you'll love. High quality, American-made beauty does not have to break the bank. Yes, you can have it all. Get in touch with us today and prepare to be pleasantly surprised.

Soft Touch Furniture
1560 South State Street
Girard, OH 44420 USA

softtouchfurniture.com
Phone: 877.747.7638 | 330.545.4204
Fax: 330.288.0083
Email: info@softtouchfurniture.com



Interested in other aspects of Soft Touch Furniture? See our other brochures



Table Tops & Bases



Booths and Banquettes



Interiors



Chairs